

496/3M-496/3P **3,0 t**



Traverse idrauliche
Hydraulic jacking beams
Traverses hydrauliques
Hydraulische Achsfreiheber

Modelli disponibili / Available versions / Versions disponibles / Lieferbare Ausführungen

Per sollevatore / Ideal on lift model / Idéal sur le pont élévateur / Für Hebebühnenmodell

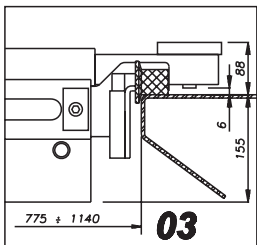

450 LT
450 ATLT

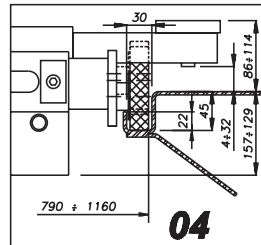

443, 442 LP

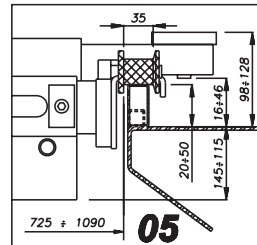

430, 430 BL, 435, 436,
450 AT

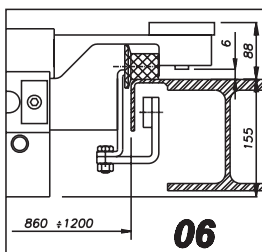

460

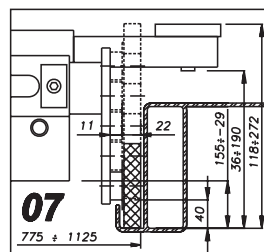

VARI
VARIOUS
PLUSIÉURS
VERSCHIEDENE

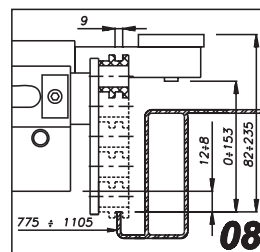

VARI
VARIOUS
PLUSIÉURS
VERSCHIEDENE

 Sollevatore
Pont élévateur
Lift
Säulen

 Rullo
Galet
Roller
Rolle

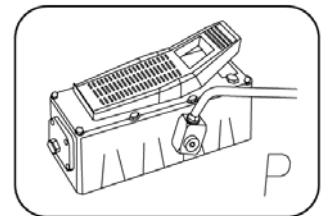
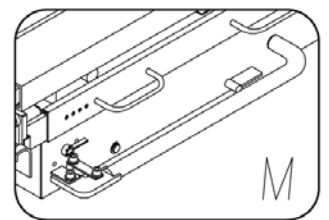

WERTHER



496/3M-496/3P

3,0 t

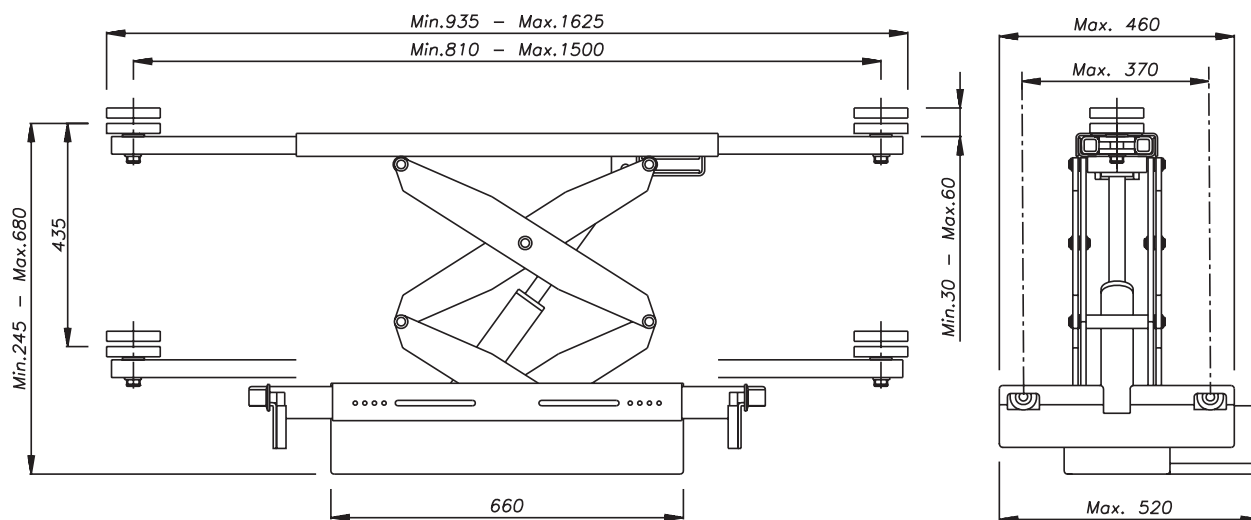

Dati tecnici - Technical data - Caractéristiques techniques - Technische Eigenschaften

Portata • Capacity • Capacité • Hubkraft	3.000 kg
Spostamento vert. del carico • Lifting height • Hauteur de levée • Hubhöhe	435 mm
Estensione min.(bracci chiusi) • Min. extension (arms retracted) • Extension min. des bras (bras rentrés) • Min. Aufnahmebreite (Arme voll eingefahren)	935 mm
Estensione min.(bracci aperti) • Min. extension (arms extracted) • Extension max. des bras (bras sortis) • Min. Aufnahmebreite (Arme voll ausgefahren)	1.725 mm
Passo delle ruote di scorrimento min. • Wheel base min. • Pas des roulettes • Achsabstand der Laufrollen	775 ± 860 mm
Passo delle ruote di scorrimento max. • Wheel base max. • Pas des roulettes • Achsabstand der Laufrollen, max.	1.105 ± 1.200 mm
Peso della traversa • Weight • Poids • Gewicht	150 kg
Temperatura di funzionamento • Operative temperature • Température d'opération • Betriebstemperatur	-10 +40°C

Opzioni - Optionals - Options - Sonderzubehör



- Kit appoggi per traversa
- Support kit for jacking beam
- Jeu de supports pour traverse
- Stützesatz für Achsfreiheber



- Estensioni per tamponi di sollevamento
- Lifting pad extensions
- Rallonges pour tampons de levage
- Hubspindelverlängerungen



WERTHER INTERNATIONAL S.p.A.

Via F. Brunelleschi, 12 - 42100 Cadè (RE) Italy - Tel. ++39 0522 9431 - Fax ++39 0522 941997
www.wertherint.com - e-mail: sales@wertherint.com

Il fabbricante, nell'ambito del costante miglioramento dei propri prodotti, si riserva il diritto di apportare modifiche senza preavviso. - The company reserves the right to introduce improvements in design or specification without prior notice. - Der Hersteller behält sich das Recht vor, im Zuge der technischen Weiterentwicklung, technische Eigenschaften ohne Vorankündigung zu ändern. - Le fabricant dans le but d'améliorer constamment ses produits, se réserve le droit d'apporter des modifications sans préavis - La compañía Werther se reserva de todos modos el derecho de aportar todas las modificaciones que considera necesarias para mejorar la estética o el funcionamiento de los productos, sin tener la obligación de avisar de ello.